

ENGLISH

I. INSTRUCTIONS FOR USE (IFU)

&

II: INSTALLATION AND FIRST USE

GazeDriver V001- Eye Steering for Wheelchairs



The GazeDriver Module with training plate on top

These instructions apply to the model: GazeDriver V001.



GazeDriver V001 meets the requirements of the EU regulation MDR 2017/745 on medical devices.

Version of “I. Instructions for Use (IFU) and II. Installation and First Use”: IFU EN 2025-01

INTENDED PURPOSE

GazeDriver is an eye-control device for wheelchairs. It is intended to be used in combination with standard powered/electrical wheelchairs to control wheelchair movement and communicate via a tablet. GazeDriver is intended for use in a home healthcare environment by people with a physical disability who can control their eye movement. Read more in I. Instructions for Use, Chapter 2.

CONTACT HEALTHCARE PROFESSIONAL

A professional with relevant healthcare skills must assess the users' ability to use a power wheelchair and whether a nearby assistant is mandatory. Read more in I. Instructions for Use, Chapter 3 and 4.

SERIOUS INCIDENTS

Any serious incident that has occurred in relation to the device shall be reported to the manufacturer and the competent authority of the Member State in which the user is established.

A serious incident is any incident that directly or indirectly led to or could cause:

- The death of a patient, user, or other person
- Temporary or permanent serious deterioration of a patient's, user, or other persons state of health
- A serious public health threat.

Report Serious Incidents to:

Eyemind ApS
Vesterbrogade 125
1620 Copenhagen
Denmark
Mail: info@gazedriver.dk

SAFETY PRECAUTIONS

To prevent harm of user, other people, or the environment:

- ⚠ Read and follow the instructions for use thoroughly. It contains important safety precautions and instructions.
- ⚠ The wheelchair shall be equipped with either a user- or assistant-operated emergency stop.
- ⚠ Do not throw or drop GazeDriver. Handle it carefully at all times to avoid damage or malfunction.
- ⚠ Do not use the GazeDriver if any part of GazeDriver is damaged.
- ⚠ Do not plug any objects other than the original equipment from the manufacturer into the connector socket. Risk of a short circuit or electric shock.
- ⚠ GazeDriver must be placed 70 cm from backrest of wheelchair.
- ⚠ Do not expose GazeDriver to high ambient temperature +40° Celsius. Risk of malfunctioning.
- ⚠ There must be an assistant when GazeDriver is being used outdoor. Only exception is if the user him/herself can operate the mandatory emergency stop. Reduces risk in case of loss of function in a dangerous place.
- ⚠ Avoid exposure of cables to sharp edges during installation and in foreseeable use. Risk of electrical fire.
- ⚠ GazeDriver must have sufficient power in order to function properly. See Technical specification. Risk of malfunctioning.
- ⚠ GazeDriver must be cleaned in accordance with the Maintenance instructions.
- ⚠ The installation of GazeDriver must be done according to Installation and First Use.
- ⚠ The settings of the GazeDriver shall be configured for users with only one eye or a prosthetic eye.
- ⚠ The seat tilt of the wheelchair shall not be adjusted so far forward that user loses balance. Risk of losing contact with the GazeDriver and user not being able to straighten the seat.
- ⚠ The software of the GazeDriver may only be updated by the manufacturer. Unauthorized access is prohibited.
- ⚠ Do not unplug any connector while driving.
- ⚠ While driving, do not press the ON/OFF button on the GazeDriver.
- ⚠ The GazeDriver module must only be connected to the electric wheelchair via the correct interface according to the Technical Specifications.
- ⚠ Unauthorized repair, modification or service of the equipment is prohibited.
- ⚠ No servicing and maintenance are allowed while the equipment is in use.
- ⚠ Do always follow the instructions in the manual for the wheelchair.
- ⚠ Do always calibrate GazeDriver. Use the calibration/training plate as directed.
- ⚠ Reflective glasses and sunglasses can impair the driving experience or calibration.
- ⚠ The GazeDriver must be dismantled when user is transported in their wheelchair in a car.
- ⚠ Don't lean on or cover GazeDriver

Contents

INTENDED PURPOSE.....	2
CONTACT HEALTHCARE PROFESSIONAL.....	2
SERIOUS INCIDENTS.....	2
SAFETY PRECAUTIONS	3
I. INSTRUCTIONS FOR USE.....	5
1. SYMBOL KEY	6
2. INTENDED PURPOSE	6
3. INDICATIONS & CONTRA-INDICATIONS.....	6
3.1 Where to use GazeDriver	6
3.2 User's ability to use GazeDriver.....	7
4. EVALUATION OF USER BY A HEALTH CARE PROFESSIONAL	7
5. EMERGENCY STOP	7
6. OVERVIEW	8
7. DRIVING AND OTHER MODES.....	10
7.1 Virtual Fields.....	10
7.2 Actions and modes.....	11
7.3 Changing Modes.....	13
7.4 Drive mode	13
7.5 Pause Mode.....	14
7.6 Simplified Driving	15
7.7 Mouse mode	15
7.8 Wheelchair settings mode.....	15
7.9 Power on and shutdown of GazeDriver ..	16
7.10 How to stop the wheelchair!.....	16
7.11 Driving in sunshine outdoors.....	16
7.12 Driving without GazeDriver	17
8. FEATURES AND SETTINGS.....	17
8.1 GazeDriver Setup menu	17
8.2 Setup of features and settings	18
9. CALIBRATION	21
9.1 Calibration for driving.....	21
9.2 Calibration of Mouse Output	25
Step-by-step guide for calibrating the mouse function	25
10. ATTACHING / DETACHING GAZEDRIVER.....	27
11. TRANSPORT	28
12. MAINTENANCE	28
13. SERVICE, REPAIR, STORAGE AND DISPOSAL	28
14. SYMBOLS AND BUTTONS.....	30
15. TROUBLESHOOTING	31
16. TECHNICAL SPECIFICATION.....	32
17. PRODUCT SERVICE LIFE AND REUSE	33
II. INSTALLATION AND FIRST USE	35
1. INSTALLATION.....	36
1.1 Required skills for installing GazeDriver ..	36
1.2 Emergency Stop.....	36
1.3 Interface	36
1.4 Battery	36
1.5 Cables	36
1.6 Installing the Splitter Module.....	37
1.7 Installing the GazeDriver Module.....	39
1.8 Attendant control	40
1.9 Initial calibration.....	40
1.10 User friendliness recommendations	40
2. FIRST USE	42
INFORMATION MANDATORY FOR THE RETAILER TO APPLY	44
RESOURCES AND SUPPORT	44

I. INSTRUCTIONS FOR USE

GazeDriver V001
- Eye Steering for Wheelchairs

1. SYMBOL KEY

Safety precautions with a coloured background must always be followed!

⚠ General warning sign! Beware of the potential harm described by this sign.

! Mandatory action sign! The action indicated by this sign is mandatory to perform.

⊘ General prohibition sign! Never perform the action described in the text by this sign.

👉 This symbol designates a point of attention or a recommendation.

[3] / 27] Refers to an illustration number.

(24) Refers to a component in an illustration.

2. INTENDED PURPOSE

! Read the instructions for use before you use GazeDriver for the first time and follow the instructions carefully.

GazeDriver is an eye-control device for wheelchairs.

It is intended to be used in combination with standard powered/electrical wheelchairs to control wheelchair movement and communicate via tablet, phone, or PC.

GazeDriver is intended for use in a home healthcare environment by people with a physical disability who can control their eye movement.

If you use the GazeDriver module or its accessories inappropriately, you may put yourself or others at risk, therefore, it is important to follow the instructions for use carefully.

👉 The required Emergency Stop is not part of the delivery! Read more in chapter 4.

👉 The communication function is not part of the basic delivery but can be purchased separately.

! Before you use the GazeDriver you must *also* always read the instructions for use for your electric wheelchair.

3. INDICATIONS & CONTRA-INDICATIONS

3.1 Where to use GazeDriver

! GazeDriver can be used in the same places where it is possible to use an ordinary electrical wheelchair.

! GazeDriver can be used in a home, healthcare environment.

GazeDriver can be used:

- Indoor without a nearby assistant.
- Outdoor with a nearby assistant.
- Outdoor without a nearby assistant if the user can operate an emergency stop.

3.2 User's ability to use GazeDriver

The user and/or an assistant can operate the functions of GazeDriver. But installation and first use must be performed as described in part II. Installation and First Use.

GazeDriver can be used by people:

- who are considered able to control a powered wheelchair with a joystick.
- who are able to assess the consequences of any action taken while using GazeDriver to drive a powered wheelchair and, if necessary, correct the actions.
- people where a professional with relevant healthcare skills (see Chapter 4) have assessed that the user's ability to use a power wheelchair is sufficient.
- Age group: People over three years old.
- Users who have control of at least one eye.

Users can wear glasses, contact-lenses, and/or have full control with one eye only.

- 👉 Reflective glasses and sunglasses can interfere with the GazeDriver contact. It can degrade the driving or calibration experience and cause unstable or unresponsive driving.
- 👉 Instead of sunglasses, a cap, hat, or head shade is recommended.

4. EVALUATION OF USER BY A HEALTH CARE PROFESSIONAL

When to Contact a Healthcare Professional:

- ❗ A professional with relevant healthcare skills must assess that the user's ability to use a power wheelchair is sufficient.
- ❗ The decision on whether a nearby assistant is mandatory and shall be taken by a qualified healthcare professional.

Definition:

"a professional with relevant healthcare skills" or "a qualified healthcare professional" is a physician, physiotherapist, occupational therapist, nurse or similar.

5. EMERGENCY STOP

- ⚠️ The wheelchair shall have an emergency stop, either to be operated by the user or an assistant.

The emergency stop (emergency stop icon, see chapter 14) shall be placed in a position where it is accessible to the user or assistant.

On some wheelchairs the on/off button is an emergency stop. See the manual for your specific wheelchair.

If the user is not able to use a manual emergency stop, an attendant emergency stop is required!

- If the user is not able to use an emergency stop (sipp / puff, neck button, foot controlled etc.), do always use the GazeDriver module with an attendant emergency stop!
- The assistant emergency stop can be part of the wheelchair or a remote emergency stop. The decision should be taken by a health care professional according to chapter 3.

6. OVERVIEW

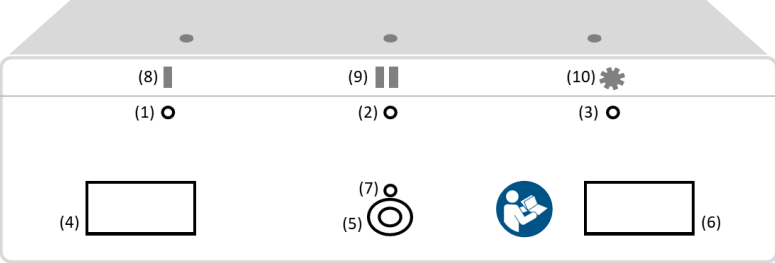
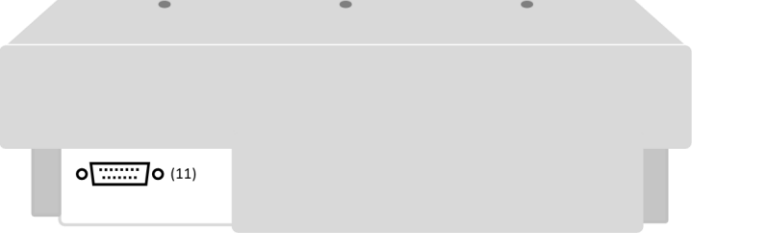
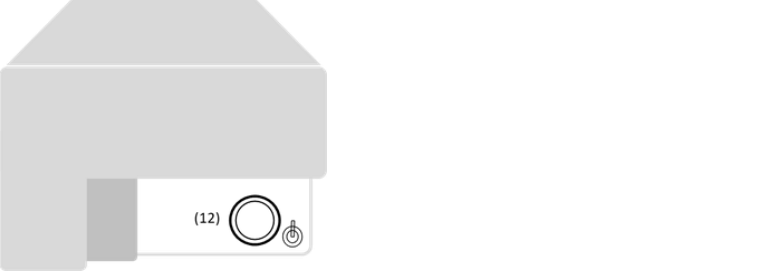
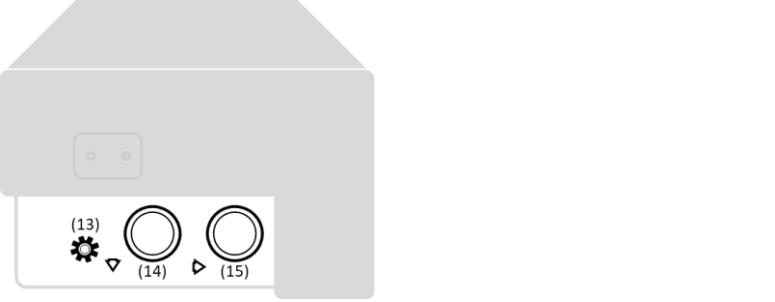
 <p>[1] GazeDriver module front</p>	<p>(1) (2) (3) LED feedback lights (4) (6) Nir lenses (near infrared) (5) Camera lens (7) Eye Tracker Feedback light (8) Reverse function (9) Pause stop/start (10) Set up menu</p>
 <p>[3] GazeDriver module back</p>	<p>(11) Connector for Main Cable [27]</p>
 <p>[4] GazeDriver module right side</p>	<p>(12) On/off button</p>
 <p>[5] GazeDriver module left side</p> <p>⊘ Above (13) is a service port. This must not be opened. Please refer to the section "Service" in chapter 13.</p>	<p>(13) Settings setup icon (14) Setup button, scroll down (15) Setup button, Click/enter</p>
<p>Cables are described in PART II: INSTALLATION AND FIRST USE</p>	

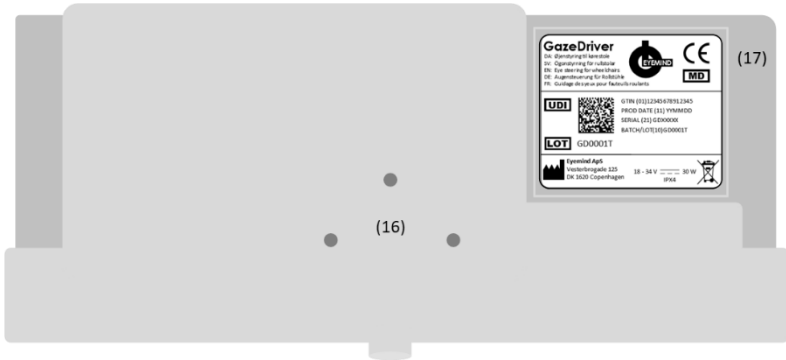
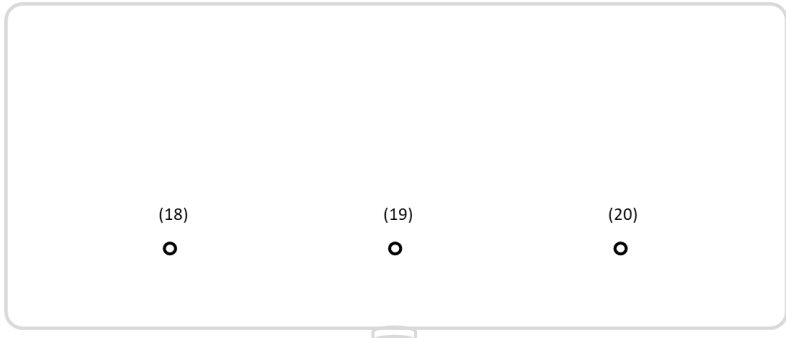
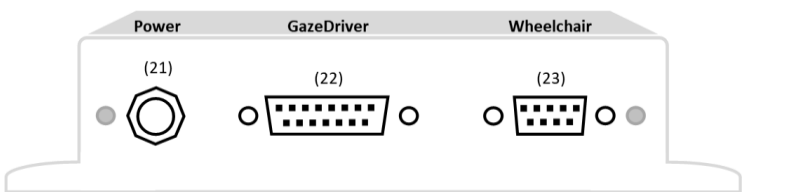
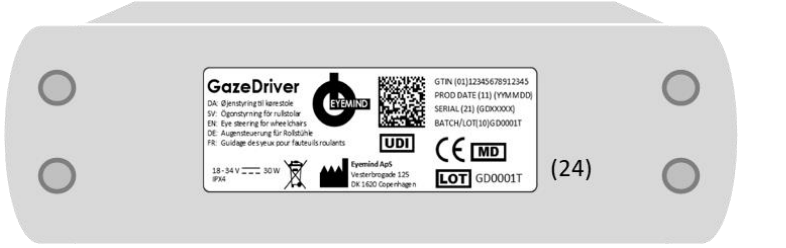
 <p>[6] GazeDriver module bottom</p>	<p>(16) Mounting holes for a Base Plate (not part of the product)</p> <p>(17) Label/marking (example) with serial number and type.</p>
 <p>[7] GazeDriver module top</p>	<p>(18) (19) (20) holes for calibration/training plate</p>
 <p>[8] Splitter module side</p>	<p>(21) Connector for Wheelchair Power Cable [29]</p> <p>(22) Connector for GazeDriver Main Cable [27] to GazeDriver module</p> <p>(23) Connector for GazeDriver Wheelchair Command Cable [28] to the wheelchair</p>
 <p>[9] Splitter module bottom</p>	<p>(24) Label/marking (example) Splitter</p>

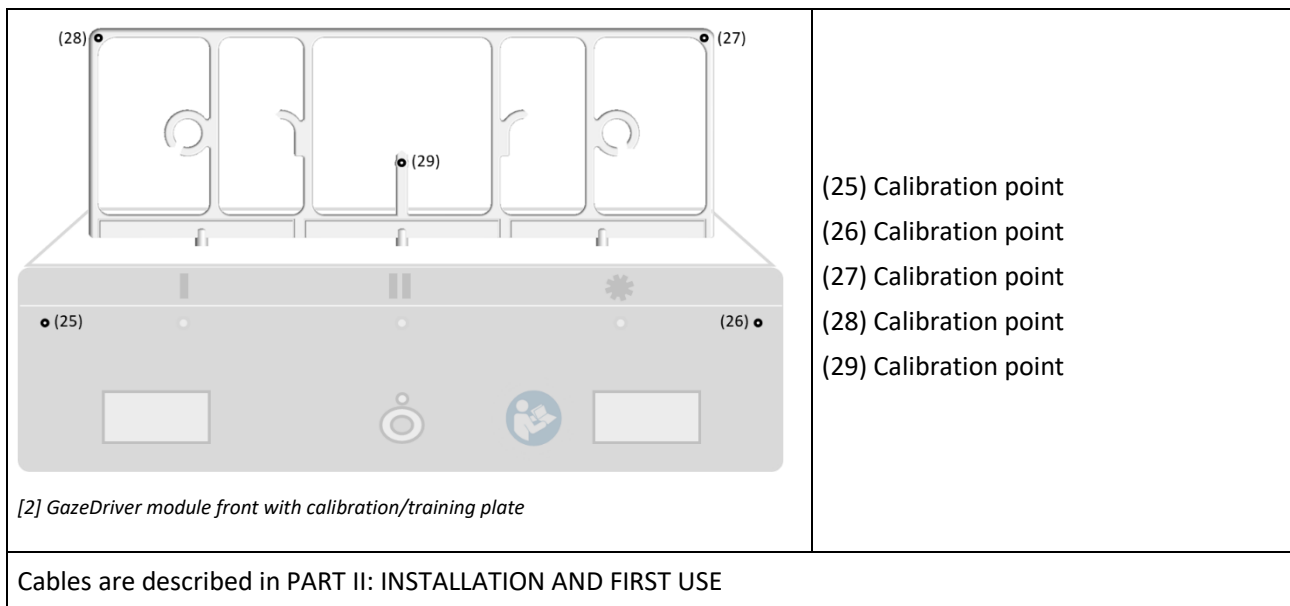

7. DRIVING AND OTHER MODES

7.1 Virtual Fields

Activate GazeDriver by looking at Virtual Fields

Above the GazeDriver module are 8 invisible virtual fields [see illustration 10]. Those functions like activation buttons. When the user looks at a virtual field an action is activated, e.g., driving or accessing the wheelchair menu.

Stop activating GazeDriver by looking away from Virtual Fields!

Driving and other functions are only activated if the user is looking at a virtual field [see illustration 10] and turns off when the user doesn't look at the virtual field or close their eyes.

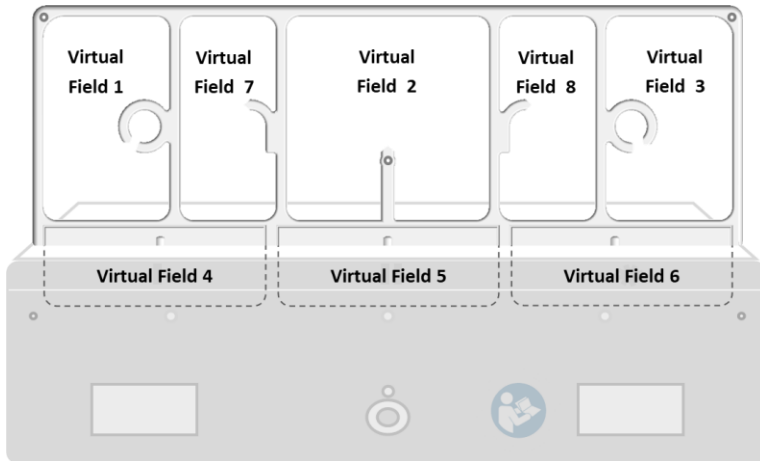











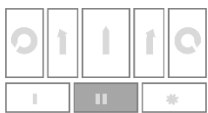







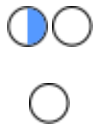

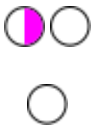

[10] GazeDriver with the virtual fields (VF).

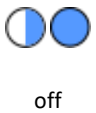

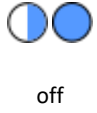

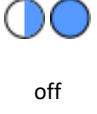

7.2 Actions and modes

This chapter describes the actions and modes activated by looking at the virtual fields [10].

Mode	Action	Virtual field	Feedback	(1)	(2)	(3)
<i>The modes of GazeDriver</i>	<i>The response to the user's input</i>	<i>Looking at a virtual field [10]</i>	<i>Feedback is given with colour, blinking and steady light</i>	<i>LED 1</i>	<i>LED 2</i>	<i>LED 3</i>
To switch to Driving mode GazeDriver must be in Pause mode						
Driving			No Feedback	off	off	off
Driving	The wheelchair stops and turns left on the spot		Blinks blue Then steady blue			
Driving	Drive forward		Blinks blue Then steady blue			
Driving	The wheelchair stops and turns right on the spot		Blinks blue Then steady blue			
Driving	Turn left while driving		Steady blue			
Driving	Turn right while driving		Steady blue			

Driving	Drive in reverse		Blinks blue / Purple Then steady purple			
Driving	Activate pause mode		Blinks purple			
Pause			Steady purple Wheelchair won't drive			
Pause	Enter driving mode		Blinks purple			
Pause	Activate wheelchair menu		Blinks blue / white Then steady white			
Pause	Activate mouse mode		Blinks purple / white Then steady white			
Wheelchair menu			No feedback	off	off	off
Wheelchair menu	Move Left		Blinks blue Then steady blue Then off		off	
Wheelchair menu	Move up		Blinks blue Then steady blue Then off			off
Wheelchair menu	Move right		Blinks blue Then steady blue Then off			
Wheelchair menu	Move down		Blinks blue Then steady blue Then off		off	
Wheelchair menu	Send click to wheelchair		Blinking blue/white			

👉 Please note! The communication function (mouse function) is optional but can be purchased separately.

Mouse mode			Steady white			
Mouse mode	Mouse click	Tablet	Blinks purple 1) Then steady purple 2) Then off 3)	1) 	2)  3) off	
Error mode	Read Troubleshooting		Blinks white	 /off	 /off	 /off

7.3 Changing Modes

⚠ Do only change the MODE when the wheelchair is in a stationary position.

GazeDriver has six possible modes: 1. driving, 2. pause, 3. wheelchair settings, 4. mouse output, 5. GazeDriver configuration and 6. error.

Using the virtual fields, you can toggle between the different modes except GazeDriver configuration and error.

Stop the wheelchair: look away from the virtual field or close the eyes.

7.4 Drive mode

👉 The training must be done with plenty of space around the wheelchair, and the wheelchair speed set to the slowest value.

In Drive mode GazeDriver controls the wheelchair driving forward, turn and reverse movement.

In drive mode, the wheelchair can travel straight, adjust to the left or adjust to the right, and turn around on the spot to the right or to the left.

To switch between driving functions, the gaze is moved to the field you want to activate, and then the driving function of that field (e.g., turn right) is activated. [10].

You release a virtual field by looking away or closing your eyes, this also activates the wheelchairs brakes and makes you stop.

- A Simplified driving mode is available. See chapter 7.6.

Driving and steering manoeuvres

Example:

To drive forward look at virtual field 2 [10].



The middle LED will start blinking and when the pre-set pause (dwell time) has passed, the wheelchair will start driving forward.

All driving follows the same principles.

Rules for steering while driving (see illustration 10 about virtual fields):

- To drive forward, look at virtual field 2.
- To stop the wheelchair and turn left on the spot, look at virtual field 1.
- To stop the wheelchair and turn right on the spot, look at virtual field 3.
- To drive in reverse, look at virtual field 4.
- To adjust the drive to the left, look at virtual field 7.
- To adjust the drive to the right, look at virtual field 8.

Braking

The electric wheelchair stops whenever you stop looking at the virtual fields [10].

For safe braking, stop looking at the virtual fields or close your eyes and the wheelchair will stop.

Speed when using GazeDriver.

When using GazeDriver, adjust the speed of the wheelchair to the surroundings using the wheelchair menu mode.

7.5 Pause Mode

- In pause mode GazeDriver do not allow any driving inputs.

In pause mode, GazeDriver does not transmit driving signals. This allows the user to look at the virtual fields without starting driving.

In pause mode the user can change modes to Wheelchair settings and Mouse mode. See chapter 7.2.

Manual pause

To **enter** pause mode the user shall look at virtual field 5 [10].



The middle LED will start blinking and GazeDriver will enter pause mode.

To **exit pause mode** user shall look at virtual field 5 [10].



The middle LED will start blinking and GazeDriver will exit pause mode. See chapter 7.2.

Changing modes follows the same principles as described under Manual Pause. See chapter 7.2.

Auto pause

GazeDriver will enter auto pause if no virtual fields [10] has been activated for a short period (dwell time) by looking at them.

To exit auto pause, follow the “exit pause mode” described above.

7.6 Simplified Driving

For users who need a simpler driving, it is recommended to leave out activating virtual fields 7 and 8 [10] in the setup.

Thus, the user only has the option to drive straight by looking at Virtual Field 2, drive left by looking at Virtual Field 1 or right by looking at Virtual Field 3.

With simplified driving, the user will automatically stop to change the direction of the wheelchair. This results in a more interrupted and thus careful driving, which can be appropriate for people who are cognitively challenged, for example.

See illustration [10] and chapter 7.2.

7.7 Mouse mode

👉 Please note! The communication function (mouse function) is optional but can be purchased separately.

Preparation: Bluetooth connection

To use the mouse output from GazeDriver you must connect your device to the Bluetooth signal “GazeDriver”.

👉 See the manual for your device on how to connect to a Bluetooth device.

How the mouse mode works

In mouse mode GazeDriver controls the cursor on the connected PC, tablet, or phone.

If the user looks within the same small area for a pre-set period (dwell-time) a left mouse click is performed.

Example

User looks at a button on a PC screen.



The right LED starts blinking for the pre-set period (dwell-time) and a left mouse button click is performed on this button.

👉 Read more about setting the dwell-time in chapter 8.2.

Exit Mouse Mode

User closes the eyes or look away from GazeDriver for 10 seconds, and GazeDriver enters pause mode.

7.8 Wheelchair settings mode

Possible soft lock

⚠ There must be an exit point in the wheelchair menu, so that the user can exit the menu.

- 👉 GazeDriver has no way of knowing where in the wheelchair menu the user currently is. So, it is possible to exit the wheelchair menu mode without exiting the menu of the wheelchair. It is also possible to exit the wheelchair menu without exiting GazeDriver's wheelchair menu mode.

Setting of Seat

- ⊘ For users who cannot straighten herself/himself up the seat tilt of the wheelchair must not be adjusted so far forward that the user can lose the balance. There is a risk of losing contact with the GazeDriver and that the user can't presume a correct seating position.

7.9 Power on and shutdown of GazeDriver

To power on GazeDriver press the power button (12). It may take several minutes for GazeDriver to be ready for driving. When started GazeDriver will be in pause mode. To power off/shutdown GazeDriver press on/off button (12).

7.10 How to stop the wheelchair!

- 👉 To stop the wheelchair from driving: Look away from the virtual field or close the eyes.

Driving and other functions are not activated when the user doesn't look at the virtual fields above GazeDriver or close their eyes.

7.11 Driving in sunshine outdoors

Before driving in sunshine, you can tilt the wheelchair's seat and back with the GazeDriver so that the sun cannot shine directly into the camera, see illustration [33]. Please Note! When the wheelchair is tilted, the wheelchair automatically moves slower.

It is recommended to wear a wide-brimmed hat, cap or head shade.

Some sunglasses can make driving outdoors easier, while others can make it difficult or impossible. Regular glasses can also affect performance in sunlight. As a solution, you can try without or with other glasses. You can also set the Blink value to 500 ms. (chapter 8.2).



[33] Shows the sun shining into GazeDriver's camera in the normal upright driving position. By tilting the wheelchair, the sun is prevented from shining directly into the camera, with which driving control can again be achieved.

7.12 Driving without GazeDriver

The wheelchair can always also be steered by Attendant Control, being the primary steering function of the wheelchair.

8. FEATURES AND SETTINGS

👉 Before the first use GazeDriver shall be calibrated and adjusted for the user.

The user or an assistant shall adjust the settings in GazeDriver to adapt to the user's need.

8.1 GazeDriver Setup menu

To set up the GazeDriver you need to enter the setup menu. Do the following:

- 👉 GazeDriver must be in Pause Mode (Modes see chapter 7.2)
- 👉 Push the setup button on GazeDriver (14)
- 👉 Connect a phone, tablet, or PC [11] to the Wi-Fi network "GazeDriver".
If the setup menu [12] doesn't appear automatically, open a browser and enter:
<http://gazedriversetup.com/> or <http://192.168.137.1>
- 👉 Browse and change the menu settings by pushing buttons (14) (15) on GazeDriver.

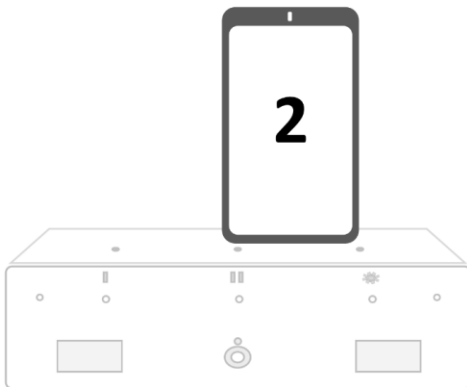

[11] Connect a phone, tablet, or PC to enter the GazeDriver Setup menu

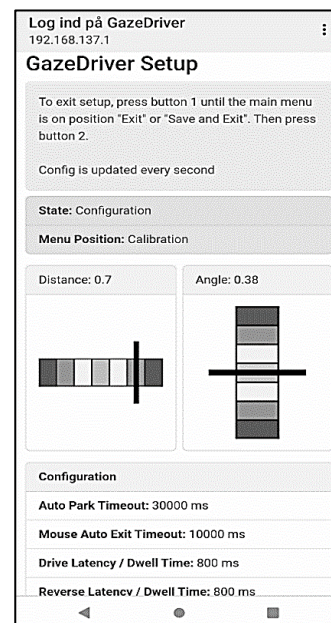



[12] GazeDriver Setup Menu menu.

8.2 Setup of features and settings

The GazeDriver has multiple setup possibilities as described in the table under.

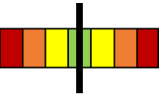
👉 The setup shall always reflect the age and abilities of the user. See chapter 3

	Feature/setting	Action
1	Meter for Distance between GazeDriver and user 	Adjust the distance between GazeDriver and the user until the bar is in the green field.
2	Meter for the Angle of GazeDriver in relation to the user 	Adjust the angle of GazeDriver in relation to the user, until the bar is in the green field.
3	Calibration <ul style="list-style-type: none"> ● Start calibration eyetracker ● Start calibration tablet ● Back 	Starts a new calibration for the driving mode of GazeDriver. Starts new calibration of the tablet mouse
4	Auto Park Timeout (in milliseconds) <ul style="list-style-type: none"> ● 10.000 ● 20.000 ● 30.000 ● 40.000 ● 50.000 ● Back 	After the set amount of time and if no interaction has taken place, GazeDriver will enter pause mode. Recommended beginner value: 30.000 milliseconds.
5	Mouse Auto Exit Timeout (in milliseconds) <ul style="list-style-type: none"> ● 3000 ● 5000 ● 10.000 ● 20.000 ● 30.000 ● 40.000 ● 50.000 Back	The time it will take to automatically exit mouse mode and enter Pause/Park mode if user looks away or closes eyes. Recommended beginner value: 5000 milliseconds. 👉 The communication function (Mouse Mode) is not part of the basic delivery but can be purchased separately.
6	Drive latency / Dwell time (in milliseconds) <ul style="list-style-type: none"> ● 300 ● 400 ● 500 ● 600 ● 700 ● 800 ● 1000 ● Back 	Dwell time is the precursor for an action. Here it's the time GazeDriver will blink before driving. Recommended beginner value: 800 milliseconds.

7	Reverse latency / Dwell time (in milliseconds) <ul style="list-style-type: none"> ● 300 ● 400 ● 500 ● 600 ● 800 ● 1000 ● Back 	<p>Dwell time is the precursor for an action. Here it's the time GazeDriver will blink before driving in reverse.</p> <p>Recommended beginner value: 800 milliseconds.</p>
8	Standby Enter latency / Dwell time (in milliseconds) <ul style="list-style-type: none"> ● 300 ● 400 ● 500 ● 600 ● 800 ● 1000 ● 2000 ● 3000 ● 4000 ● Back 	<p>Dwell time is the precursor to an action. Here it is the duration of GazeDriver's blink before you put GazeDriver in pause mode.</p> <p>Recommended starting value: 1000 milliseconds.</p> <p>Some users look down to stop the wheelchair and therefore easily put the GazeDriver in standby. A longer dwell time can remedy the problem.</p>
9	Standby Exit latency / Dwell time (Pause Mode) (in milliseconds) <ul style="list-style-type: none"> ● 300 ● 400 ● 500 ● 600 ● 800 ● 1000 ● 2000 ● 3000 ● 4000 ● Back 	<p>Dwell time is the precursor for an action. Here it's the time GazeDriver will blink before taking GazeDriver out of Pause Mode.</p> <p>Recommended beginner value: 800 milliseconds.</p> <p>A short dwell time is not recommended for inexperienced users, but makes it easy for the experienced user to get started quickly.</p>
10	Function latency / Dwell time (in milliseconds) <ul style="list-style-type: none"> ● 300 ● 400 ● 500 ● 600 ● 800 ● 1000 ● 2000 ● 3000 ● 4000 ● Back 	<p>Dwell time is the precursor for an action. Here it's the time GazeDriver will blink before entering the wheelchair settings menu.</p> <p>Recommended beginner value: 2000 milliseconds.</p>

11	<p>Mouse Enter Latency/Dwell time</p> <ul style="list-style-type: none"> • 200 • 300 • 400 • 500 • 600 • 800 • 2000 • 3000 • 4000 • Back 	<p>Dwell time is the precursor for an action. Here, it is the duration of GazeDriver's blink before entering Mouse/Tablet mode</p> <p>Recommended beginner value: 2000 milliseconds.</p> <p>👉 The communication function (Mouse Mode) is not part of the basic delivery but can be purchased separately.</p>
12	<p>Mouse click latency / Dwell time</p> <ul style="list-style-type: none"> • 300 • 400 • 500 • 600 • 800 • 1000 • Back 	<p>Dwell time is the precursor for an action. Here it is the period that GazeDriver waits after scanning a mouse click. A left click is performed after the dwell time.</p> <p>Recommended beginner value: 800 milliseconds.</p> <p>👉 The communication function (Mouse Mode) is not part of the basic delivery but can be purchased separately.</p>
13	<p>Mouse click start latency / Dwell time (in milliseconds)</p> <ul style="list-style-type: none"> • 200 • 300 • 400 • 500 • 600 • 800 • 1200 • No-Click • Back 	<p>Dwell time is the precursor for an action. Here it's the time GazeDriver scan for a mouse output (Left click)</p> <p>If the value "No-Click" is selected, a mouse click is not seen for the tablet.</p> <p>Recommended beginner value: 400 milliseconds.</p> <p>👉 The communication function (Mouse Mode) is not part of the basic delivery but can be purchased separately.</p>
14	<p>Blink (in milliseconds)</p> <ul style="list-style-type: none"> • 150 • 300 • 500 • 700 • Back 	<p>Filters out unconscious blinks from the user.</p> <p>Recommended value: 300 milliseconds.</p>
15	<p>Eyes</p> <ul style="list-style-type: none"> • Both • Left • Right • Back • Any 	<p>Allows GazeDriver to track both users' eyes <i>or</i> only left eye <i>or</i> right eye <i>or</i> any eye which is used to view with.</p> <p>Recommended value: Any Eye</p>
16	<p>Driving</p> <ul style="list-style-type: none"> • Normal Driving • Simplified Driving • Back 	<p>Allows the user to make course corrections while driving.</p> <p>Recommended beginner value: Allow</p>

17	Function <ul style="list-style-type: none"> ● Allow access to wheelchair settings ● Disallow ● Back 	Allows the user to access and change the setting of the wheelchair e.g. seating, speed and more. Recommended beginner value: Disallow
18	Allow mouse state <ul style="list-style-type: none"> ● Allow ● Disallow ● Back 	Allows the user to change GazeDriver's mode to mouse output. Recommended beginner value: Disallow
19	Tablet height	Tablet height must be set for tablet calibration and mouse output to work (in pixels). After the change, the tablet must be calibrated again. 👉 If this value is changed, calibration for driving must be repeated. GazeDriver does not allow driving until this is done. 👉 The communication function (Mouse Mode) is not part of the basic delivery but can be purchased separately.
20	Tablet width	Tablet width must be set for tablet calibration and mouse output to work (in pixels). After the change, the tablet must be calibrated again. 👉 If this value is changed, calibration for driving must be repeated. GazeDriver does not allow driving until this is done. 👉 The communication function (Mouse Mode) is not part of the basic delivery but can be purchased separately.
21	Other configurations are read only and are used for error handling only.	

9. CALIBRATION

9.1 Calibration for driving

Preparation before calibration: The calibration/training plate

The calibration/training plate [2] must be used to calibrate the driving function of the GazeDriver.

Insert the calibration/training plate into the holes on the top of the GazeDriver module as shown in the illustration [2] below.

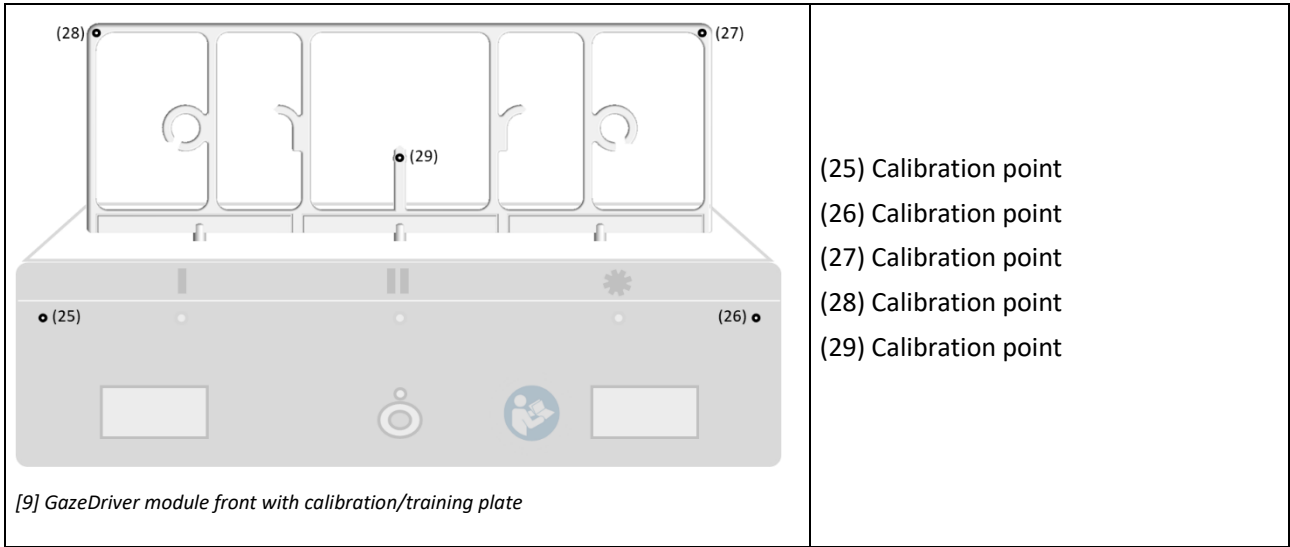

Step by step guide for calibrating the driving function

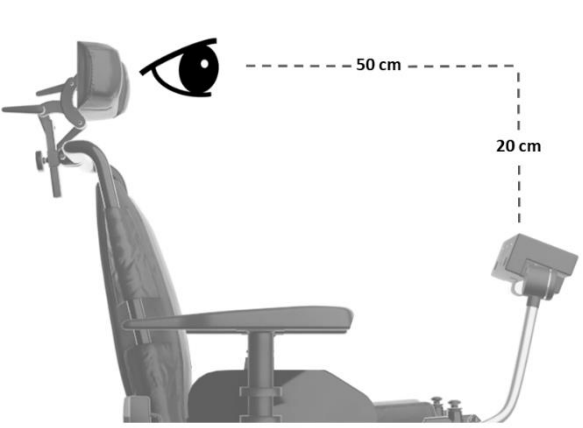
Step	Description
1	Be seated as you will be seated while using GazeDriver
2	<p>Adjust GazeDriver's height and distance to your eyes. Front of GazeDriver shall be approximately 50 cm from users' eyes and approximately 20 cm below users eyes and angled to point at users eyes [13]. There must be no obstructions between users' eyes and the front of GazeDriver.</p>  <p>[13] Recommended distances between user's eyes and GazeDriver Module</p>
3	To calibrate the GazeDriver enter the setup menu
4	GazeDriver must be in Pause Mode (Modes se chapter 7.2)
5	Push the setup button (14) on GazeDriver

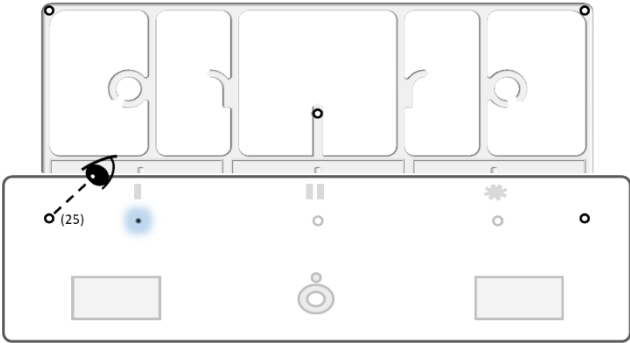
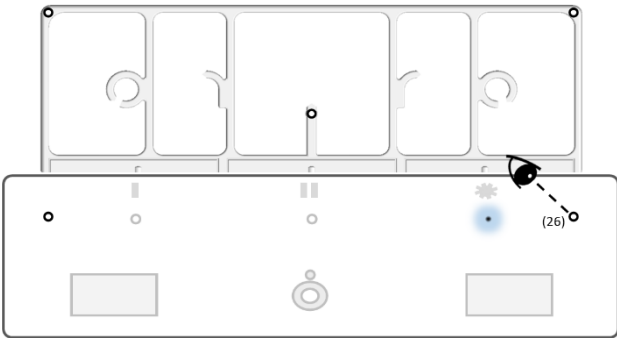
6	The assistant must connect a phone, tablet, or PC to the Wi-Fi network "GazeDriver"
7	If the setup menu doesn't appear automatically, open a browser, and refresh a page
8	If asked for a password enter - 12345678
9	The meters for Distance and Angle (see chapter 8.2) should be in the green field. If not, adjust to best possible result.
10	Choose "Start Calibration Eye tracker" in the menu by pushing buttons (14) (15) Browse by pushing button (14) Select by pushing button (15)
11	GazeDriver's Feedback LED's will flash white for a while (1) (2) (3)
12	<p>When left LED blinks blue look at left white spot (25) on the cabinet</p>  <p>[14]</p>
13	<p>When right LED blinks blue look at right white spot (26) on the cabinet.</p>  <p>[15]</p>

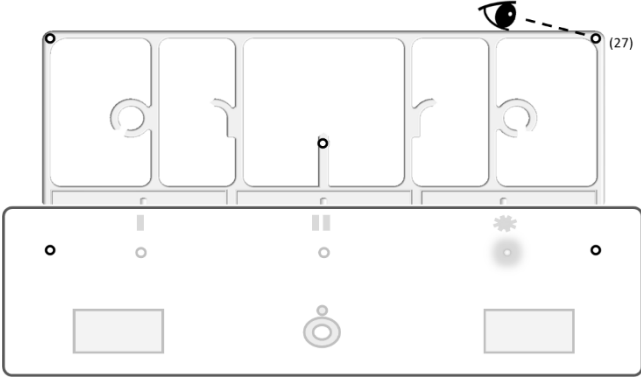
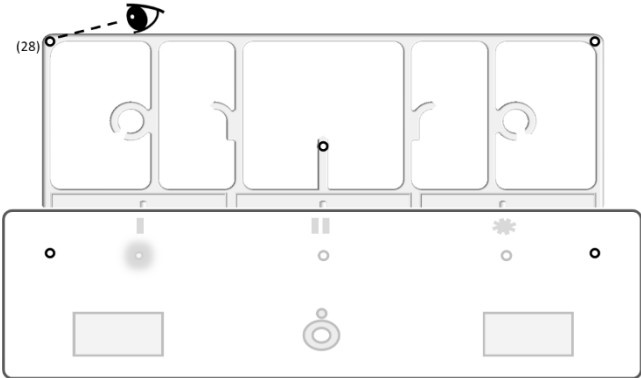
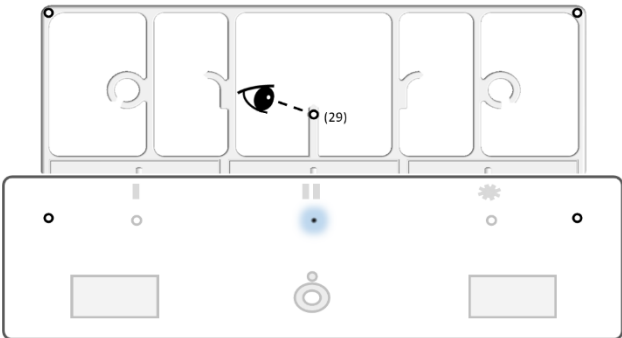
14	<p>When right LED blinks white (3) look at right white spot on the calibration/training plate (27).</p>  <p>[16]</p>
15	<p>When Left LED blinks White (1) look at left white spot on the calibration/training plate (28).</p>  <p>[17]</p>
16	<p>When middle LED blinks Blue (2) look at middle white spot on the calibration/training plate.</p>  <p>[18]</p>
17	<p>If calibration is successful, the process will end, and all LED's will flash green (1) (2) (3) If calibration was unsuccessful, the process will repeat.</p>

18	Go to “Save and Exit” and choose “Save”
----	-----------------------------------------

Calibration frequency of driving function

! Calibration shall be done if user has problems interacting with the virtual fields. The interaction shall be smooth and steady.

9.2 Calibration of Mouse Output



! Please note! The communication function (mouse function) is optional but can be purchased separately.

Preparation before calibration: Install the calibration app

Before use, GazeDriver needs to be calibrated to the screen of the user's device (tablet, phone, or PC). To do this, you must download the calibration app for your device here:

PC	Download at GazeDriver.com
Android	Search for and install GazeDriver app via Google Play

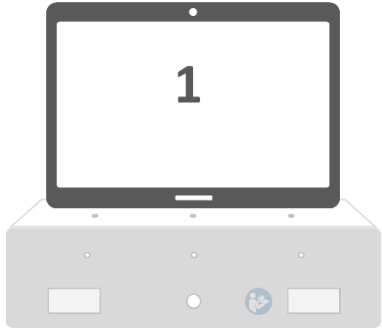
Step-by-step guide for calibrating the mouse function

	Step	Illustration
1	<p>Place your communication device (tablet, phone, or PC) over the GazeDriver Modul.</p> <ul style="list-style-type: none"> The location of the device should be centred in the middle and above the GazeDriver. See 1, illustration [19]. Make sure the device is fixed and can't move. <p>The device is not part of the GazeDriver.</p>	 <p>[19]</p>
2	<p>Connect the device being calibrated for (the tablet, phone, or PC) to the Bluetooth signal “GazeDriver”.</p>	 <p>[20] Bluetooth icon on tablet/phone/computer</p>

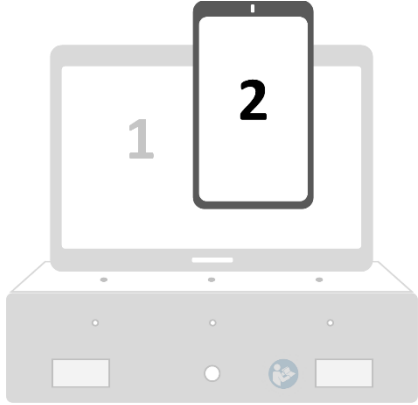
3	On your device, run the GazeDriver app	-
4	Read the width and height values in the app	-
5	Connect another device to the WIFI network "GazeDriver". See 2, illustration [21].	 <p>[21]</p>
6	To calibrate the mouse function in GazeDriver, enter the screen size in the setup menu (if the values don't already match)	Setup menu: See chapter 8.1
7	Press the button (14) (15) on the GazeDriver until you reach the menu: "Tablet width/Tablet height".	See illustration [5]
8	Insert the values for height and width by pushing button (14) (15).	<p>See illustration [5]</p> <p>👉 If this value is changed, calibration for driving must be repeated. GazeDriver does not allow driving until this is done.</p>
9	Go back to the menu: "Start Calibration Tablet".	-
10	Select menu item: "Start Calibration Tablet".	-
11	GazeDriver's LED's (1) (2) (3) will flash white for a moment.	See illustration [1]

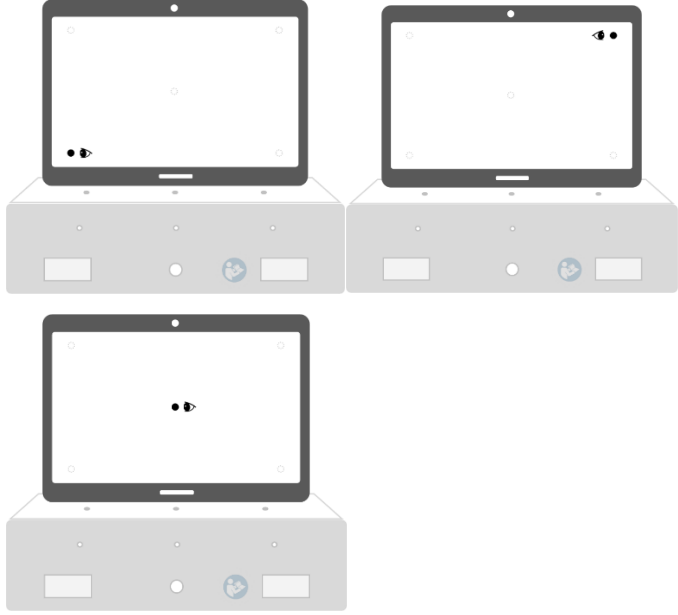
12	<p>Follow the dot on the screen with your eyes, while it moves around. The dot will show up 9 or 16 times depending on your calibration choice. See illustration [22].</p> <p>The middle LED (2) will blink blue while a point is being calibrated.</p>	 <p>[22]</p>
13	<p>If calibration is successful, the process will end, and all LED's will flash Green (1) (2) (3).</p>	-
14	<p>If Calibration was unsuccessful, the process will repeat.</p>	-

Calibration frequency of mouse function

! Calibration shall be done if user has problems interacting with the device. The interaction should always be smooth and steady.

10. ATTACHING / DETACHING GAZEDRIVER

GazeDriver can be attached from the holding arm or with the holding arm. The GazeDriver power shall be turned off (12) during this operation. To attach or detach GazeDriver from the holding arm, connect/disconnect the Main Cable [27] from the backside of the cabinet (11) using the finger screws on the Main Cable [27].

To attach/detach GazeDriver with the holding arm, connect/disconnect the Main Cable [27] from the Splitter (22) using the finger screws on the cable.

11. TRANSPORT



- GazeDriver must be dismantled when the user is transported in their wheelchair in a car.
- GazeDriver must always be switched off when GazeDriver is on an airplane.
- The instructions for the transportation of power/electrical wheelchairs as described in the user manual for the power wheelchair shall be followed. When it is instructed in the wheelchair manual to switch off the electrical functions of the wheelchair the GazeDriver shall be switched off by using the on/off button (12) on the GazeDriver Module.
- When using the GazeDriver do always follow the safety instructions for the relevant means of transportation.
- The safety instructions of the responsible transportation company shall be followed.

12. MAINTENANCE

Cleaning

 Do not use aggressive cleaning agents, such as solvents, or stiff brushes etc.



- Clean the GazeDriver Modul with a wrung-out cloth with water only or a mild cleaning agent, like hand dishwashing soap.
- Cleaning of the GazeDriver Modul should be done twice a year.
- Keep the feedback lights (1)(2)(3), the NIR Lenses (4) (6) and Camera lens (5) clean. Dirt can prevent the GazeDriver from functioning properly. Be careful when cleaning not to scratch the lenses - only use very soft tissue.
- Do not expose GazeDriver to water jets - it can damage the electronics and control module.

Disinfection

Fill dispenser spray bottle with 100% pure isopropyl alcohol. Spray lightly on all surfaces, wipe with clean, lint-free cloth. Be careful when wiping Nir lenses (4) (6) and Camera lens (5).

Test Emergency Stop

 Test the emergency stop(s) for the wheelchair as specified by the wheelchair manufacturer and/or the manual for the emergency stop.

13. SERVICE, REPAIR, STORAGE AND DISPOSAL

Damage

 Do not use the GazeDriver if any part of the GazeDriver is damaged. If either of the GazeDriver module [1], Splitter module [8], or cables [27] [28] [29] are damaged the GazeDriver shall be send back to the distributor or your retailer.

Examples of damage can be: Cabinet [1] [8] is broken, LED (1) (2) (3) is not working, NIR Lense (4)(6) is broken, cables are torn [27] [28] [29].

Service

⊘ No modification of this equipment is allowed.

! If the GazeDriver module is malfunctioning or defective it shall be returned to the retailer.

To decide whether the GazeDriver module is defect go through this process:

- Step 1: If the GazeDriver doesn't perform as required do always go through the troubleshooting process - described in chapter 15.
- Step 2: If the GazeDriver after the troubleshooting process still does not perform as required it must be carefully inspected by the distributor/retailer who installed the GazeDriver.
- Step 3: If the GazeDriver after the distributor/retailer has inspected the GazeDriver still does not perform as required it must be sent to the manufacturer.

⚠ Only the manufacturer may open the cabinet of the GazeDriver.

Only the manufacturer can decide whether the GazeDriver and accessories can be repaired and reused.

Replacement parts

⚠ Only original replacement parts may be used! Components from other manufacturers may cause malfunctions.

Replacement parts can only be obtained from the manufacturer or the distributor/retailer.

Storage

Storage shall be in the original storage box that the GazeDriver was received in from the manufacturer.

See also Chapter 16 on Technical Specifications.

Packaging damaged

If the packaging is damaged upon receipt, the product and the damaged packaging are returned to the retailer.

Warranty







If the Instructions for Use and the Installation instructions are not followed the product is no longer covered by the Warranty.

Disposal

⚠ The product should not be discarded as unsorted waste but must be sent to separate collection facilities sorted as "electrical" for recovery and recycling. See also chapter 14.

14. SYMBOLS AND BUTTONS

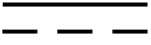
Symbols used on the product.

Symbol	Description
	CE marking combined with the “MD” shows the product's compliance with EU legislation MDR 2017/745.
	Unique Device Identifier of the product and the manufacturer.
SN	The use of the letters “SN” in the data matrix indicates the manufacturer’s serial number so that the specific medical device can be identified.
LOT	The use of the letters “LOT” in the data matrix indicates the manufacturer’s batch code so that the batch can be identified.
	Name and address of the manufacturer and the date of manufacture.
	The instruction for use must be read before using or installing the GazeDriver.
	WEEE icon. The product should not be discarded as unsorted waste but must be sent to separate collection facilities for recovery and recycling.
	The product is suitable for direct current only
	On/off icon (12)
	Settings setup icon (13) indicates where to enter the settings. See also (14)(15)

	Emergency Stop Icon
-----------------------------------------------------------------------------------	---------------------

15. TROUBLESHOOTING

Error	Solution
<p>The wheelchair doesn't drive when looking at the virtual fields</p>	<p>Check the mode of GazeDriver. See chapter 7.2. Re-calibrate GazeDriver. See chapter 9.1. Check position of GazeDriver. See illustration [14] Re-start GazeDriver. See chapter 7.9.</p>
<p>The mouse function doesn't work appropriately when I want to use my tablet device.</p> <p>👉 Please note! The communication function (mouse function) is optional but can be purchased separately.</p>	<p>See chapter 9.2: Check Bluetooth connection on tablet. In GazeDriver setup, check if screen width and height match the tablet. Re-calibrate the mouse output.</p>
<p>I can't change mode from drive mode to mouse mode and/or from communication mode to drive mode</p> <p>👉 Please note! The communication function (mouse function) is optional but can be purchased separately.</p>	<p>Check menu settings to see if mouse mode is activated. See chapter 8.2. Check mouse mode exit settings. See chapter 8.2. Restart GazeDriver. See chapter 7.9.</p>
<p>I can't enter the settings menu on the wheelchair</p>	<p>Check menu settings to see if wheelchair settings mode is activated. See chapter 8.2. Restart GazeDriver. See chapter 7.9. Check the wheelchair's settings. Are menu commands allowed?</p>
<p>The GazeDriver doesn't work outdoor</p>	<p>Rain, sun, heat and sunglasses may interfere with the performance of GazeDriver. Keep the lenses (4) (5) (6) dry and clean. In strong sunshine, follow the instructions in chapter 7.11.</p>

GazeDriver won't start	<p>First check whether the battery on the wheelchair is charged and that the battery functions appropriately. Follow the instructions in the manual for the wheelchair.</p> <p>Make sure that the cables are correctly connected. See illustration [3] and [8].</p> <p>Make sure that the cables are not damaged. This shall always be done by a professional with the relevant technical experience (See II. Installation and First Use, chapter 1.5 & 1.6)</p> <p>If GazeDriver still doesn't work, it must be sent back to retailer.</p>
Defective feedback LED	The GazeDriver must be send back to retailer.
The NIR lights (4) (6) are not turned on	<p>GazeDriver is not started. See (12), illustration [4].</p> <p>Restart GazeDriver. See chapter 7.9.</p> <p>GazeDriver is defective and must be send back to retailer.</p>
GazeDriver has detected an error (The three feedback LED's blinks white)	<p>Restart GazeDriver. See chapter 7.9.1.</p> <p>If problem persist GazeDriver must be send back to the retailer</p>
GazeDriver will not start when it is very hot (GazeDriver is 40 °C or more).	GazeDriver is overheated. Take the GazeDriver into the shade/indoors until it has cooled below 40 °C.
GazeDriver will not start when cold (GazeDriver is below 5°C).	Take GazeDriver into a warm environment (e.g., indoors) for an hour and restart GazeDriver.

16. TECHNICAL SPECIFICATION

Environmental operating temperature range	+5 °C to +40 °C
Storage temperature range	-25 °C to +70 °C
Enclosure class	IP24
Compatible with wheelchairs	With R-Net or LiNX systems.
Compatible wheelchair driving controllers' manufacturers/models	<p>OMNI SPECIALITY CONTROL INTERFACE</p> <p>OMNI2 SPECIALITY CONTROL INTERFACE</p> <p>Dynamic Controls DLX-IN500-A and either a DLX-REM400-B or DLX-REM500-A</p>
Interface and power connector	<p>D-Sub 15 (GazeDriver module)</p> <p>D-Sub 9 (Wheelchair interface)</p> <p>M5 ring terminal (Battery connection)</p>
Input	18 V - 34 V d.c. 30 W

Size GazeDriver Module	Length: 300 mm Width: 130 mm Height: 80 mm
Size Splitter Module	Length: 152mm Width: 46 mm Height: 30 mm
Weight of GazeDriver Module	1180g
Weight Splitter including all cables	405g
Intermediate power supply (if used)	18-34 V d.c. minimum 30 watts.
Fuse specification	Cartridge 1.6 A, 250 V, slow blow, 6x32 mm (Recommended Littelfuse 326 series)
Wheelchair battery charger	Must provide at least 1 MOP (means of protection) from supply mains
The range of the eye tracker	50 cm - 60cm (from user eyes)
Radio frequency range	2.4 GHz / 5 GHz Maximum output power: +18.5 dBm
Electrical Safety Classification	Class II / Internally powered*
ISO 7176-14	This product met all the requirements of ISO 7176-14
ISO 7176-14 - forces	No force needed by the user
Internal software version	1.0.0.4

**In the Electrical Safety Classification GazeDriver is considered a class II medical equipment when connected to any external power supply that provides a means of connection to supply mains, as is usually the case with a wheelchair battery charger. Other than this, it is considered internally powered.*

17. PRODUCT SERVICE LIFE AND REUSE

GazeDriver (including all accompanying parts) is designed for a service life of up to 4 years.

This only applies if appropriately trained service personnel are used, and GazeDriver is installed and used in accordance with the I. Instructions for Use and II. Installation and First Use manual.

Reuse of product

The GazeDriver V001 eye control is generally suitable for reuse.

Before reuse all hardware (described in the “I. Instructions for Use” chapter 6, and chapter 1.5 of the “II. Installation and First Use manual”) must be returned to the manufacturer, Eyemind ApS, to perform the following actions:

- Cleaning and disinfection of the product (to prevent infection)
- Photo documentation of the component
- Functional testing of the component (hardware)
- Verification of the software
- Reset of individual settings (GazeDriver does not collect any personal data)

II. INSTALLATION AND FIRST USE

For professionals only

1. INSTALLATION

1.1 Required skills for installing GazeDriver

- ! The installation of GazeDriver must be done by service personnel with the relevant technical experience by processing the relevant education and/or work experience on mounting of technical equipment on wheelchairs.
- ! Some authorities with jurisdiction impose additional requirements for qualification of service personnel.

Manufacturer is responsible for the effect on basic product performance *only* if appropriately trained service personnel are used, and GazeDriver is installed and used in accordance with the I. Instructions for Use and II. Installation and First Use manual.

1.2 Emergency Stop

- ! A manual emergency stop shall be connected to the wheelchair before use! To prevent harm of user, other people, or the environment

The manual emergency stop is not part of the GazeDriver Module.

- See I. Instructions for Use, Chapter 5, on Emergency Stop.

1.3 Interface

- ! The GazeDriver module must only be connected to the electric wheelchair via an interface as described in the Technical Specifications, chapter 16.

1.4 Battery

- ! Follow the instructions in the user manual for the wheelchair on charging the wheelchair battery.
- ! Make sure that the batteries of the wheelchair are charged before using GazeDriver!

The GazeDriver gets power from the wheelchair battery. The GazeDriver can only function if the battery of the wheelchair is sufficiently charged. Recharging is advisable before using the GazeDriver.

1.5 Cables

- ! The cables are part of the GazeDriver. Only original replacement parts may be used!
- ! Components from other manufacturers may cause malfunctions.

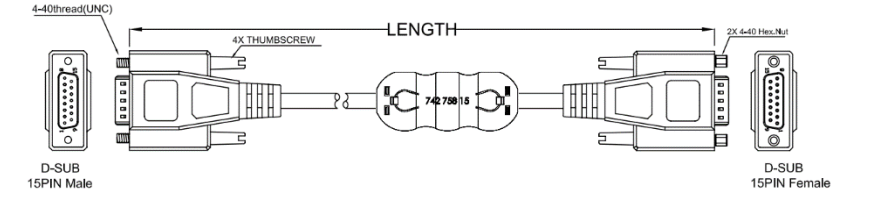
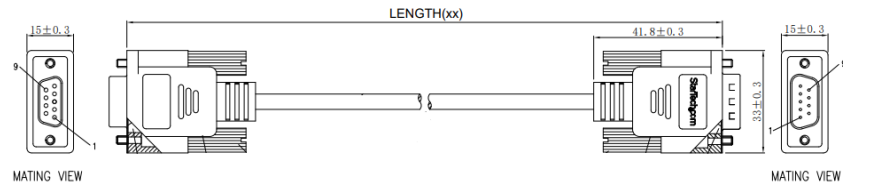
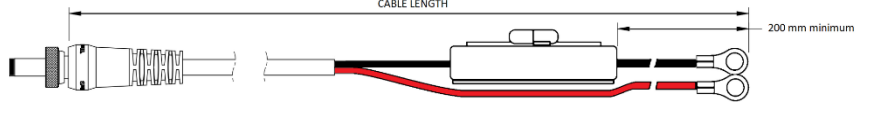
Cables for GazeDriver	Description
 <p>[27] GazeDriver Main Cable</p>	<p>GazeDriver Main Cable.</p> <p>DSub 15 cable, Male/Female ends. A ferrite split core is added to the cable.</p>
 <p>[28] GazeDriver Wheelchair Command Cable</p>	<p>GazeDriver Wheelchair Command Cable.</p> <p>Dsub 9 cable, Male/Female ends.</p>
 <p>[29] Wheelchair Power Cable</p>	<p>Wheelchair Power Cable with fuse holder.</p>

1.6 Installing the Splitter Module

Installation of the Splitter Module

The Splitter module [8] is a necessary part of GazeDriver. It allows the user to dismount the holding arm for GazeDriver without having to cut zip ties holding the cable to the holding arm and avoids loose cables when the holding arm is removed.

The splitter module shall be mounted on the wheelchair in a secure place near the base of the holding arm and allow for connecting / disconnecting of the GazeDriver Main Cable [27] to GazeDriver. See Illustration [30].

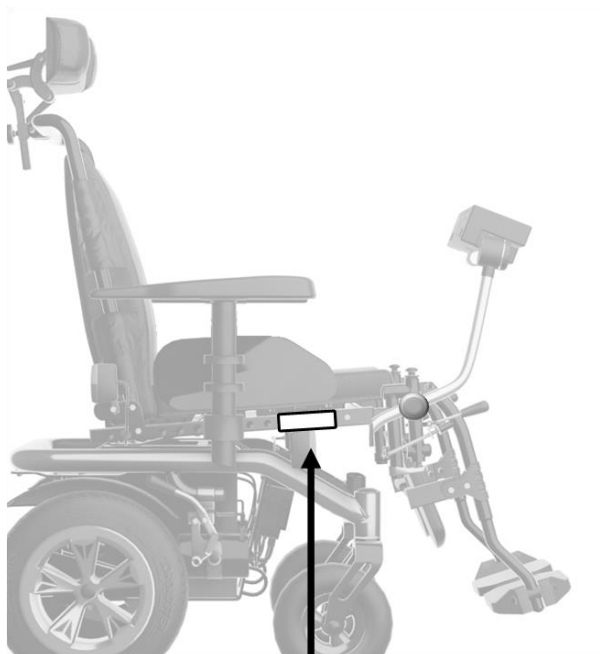

[30] The Splitter must be placed close to the base of the holding arm. Example of placement of the Splitter on this wheelchair.

Connection to Wheelchair Interface

The Wheelchair Command cable [28] is connected to the wheelchair interface with a Dsub-9 connector. The screws on the connector must be tightened firmly. For more information see the manual for the interface. For information on compatible interfaces see I. Instruction for Use, chapter 16.

Connection to wheelchair power

The connection to the wheelchair power must always be fused.

When connecting to the wheelchair do only use: Littelfuse 326 series 1.6A fuse slow blow or equivalent. For guidance on how to connect to the wheelchairs power, see the manual for the wheelchair.

Intermediate Power Supply

If the wheelchair's batteries are not in the voltage range of 18-34 V d.c. a power supply capable of delivering 30W at 18-34V d.c. can be used to power GazeDriver. This intermediate power supply connects to the splitter module's DC receptacle with a 2.5mm/5.5mm (Inner Diameter / Outer Diameter) plug with floating lock ring.

Routing of cables

⊘ Avoid exposure to sharp edges during installation and in foreseeable use.

When installing the cables for GazeDriver it is important to route the cables in such a way that they are not exposed to sharp edges, stretching, or pinching when driving or changing the tilt, height or other movable parts of the wheelchair.

Insulation against mains power

⚠ Wheelchair or charger must provide insulation against mains power. GazeDriver relies on the external battery charger providing at least 1 MOP to supply mains.

1.7 Installing the GazeDriver Module

Before installation a proper Base Plate shall be mounted (not part of GazeDriver) at the designated inserts on the bottom of GazeDriver (16).

Mounting of the GazeDriver Module

GazeDriver shall be mounted on a sturdy arm in front of the user. The arm must be sturdy enough to not vibrate during driving since this will degrade the user experience. The Main Cable [28] shall be mounted securely to the arm to avoid snagging or pinching. If holding arm has moveable joints - take this into consideration.

Insert MainCable [28] into the Dsub-15 connector on the back of GazeDriver [3] and secure the finger-screws firmly.

Mount the holding arm so that it moves together with the wheelchair when tilted back, ensuring the GazeDriver maintains a consistent eye distance for the user, regardless of the wheelchair's position. Refer to illustration [31] for guidance. Refer to illustration [31] and consult the Instructions for Use, section 7.11.

To allow the user to exit the wheelchair or switch between assistive devices, GazeDriver must be easily removable or movable (e.g., to the side or upward) and then returned to its exact original position. Use brackets and a mounting system that ensure GazeDriver (whether on an arm or used alone) always returns to the same eye distance from the user.

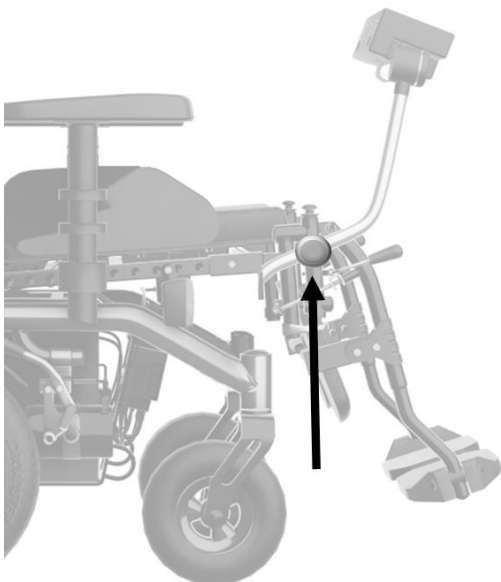

[31] The holding arm must be mounted so that it follows the user when the wheelchair is tilted. This ensures that the user maintains the same eye distance to the GazeDriver. This is an example.

Distance from backrest

! GazeDriver must be placed no closer than 70 cm from backrest of wheelchair. See illustration [32].

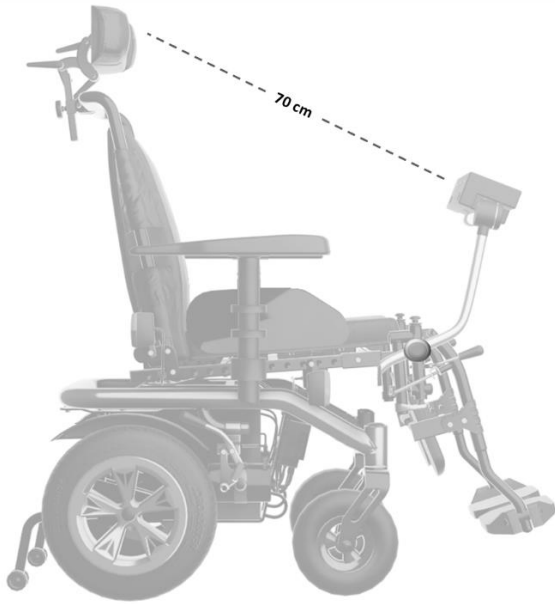

[32] Minimum distance between backrest and GazeDriver Module: 70 cm.

Setting of Seat

- ⊘ The seat tilt of the wheelchair must not be adjusted so far forward that user loses balance. Risk of losing contact with the GazeDriver.

For users who cannot straighten herself/himself up the seat tilt of the wheelchair must not be adjusted so far forward that the user can lose the balance. There is a risk of losing contact with the GazeDriver and that the user can't presume a correct seating position.

Ideally, the seat setting should be adjusted so that it is not possible for the user to lean forward so much that he/she loses balance. The seat adjustment must be carried out by a person with the necessary skills, see chapter 1.1 in II. INSTALLATION AND FIRST USE.

1.8 Attendant control

The GazeDriver module can be used together with an Attendant Control which enables an attendant to control the wheelchair.

- ⓘ Follow the instructions in the Operating Manual for the wheelchair and/or the Operating Manual for the joystick module when connecting Attendant Control to the wheelchair!

1.9 Initial calibration

When GazeDriver is started for the first time, a calibration is needed for GazeDriver to work. Until this is done, GazeDriver will not allow output to the wheelchair. Go through the calibration process as described in I. Instructions for Use, Chapter 9.1.

1.10 User friendliness recommendations

For best possible user experience the following adjustments should be considered but are not limited to:

- Fit the wheelchair with a proper head support.
- Adjust acceleration and braking forces down to get softer movement.
- Use a gyro stabilizer.
- Create different wheelchair profiles for different situations (indoor, outdoor, tight spaces).
- Use sticky inputs or similar function in the user's wheelchair settings menu.
- Remove unnecessary menu items.
- An 'exit menu' option should be available to avoid soft-locks. See I. Instructions for Use, chapter 7.9.
- Order the wheelchair menu so that the most used menu items are in the top of the menu.
- Equipment that the user needs to control with GazeDriver e.g. Omni, LiNX, or other visual outputs should be placed as close to the side of GazeDriver as possible.

2. FIRST USE

- Before using GazeDriver the steps described in this chapter shall be followed.

! First Use must be done by a person who has the skills described in chapter 1.1. in the II. INSTALLATION AND FIRST USE.

- The user of the GazeDriver must be part of the First Use, or First Use should be repeated before the user is to operate GazeDriver.

	FIRST USE ACTION	ACCEPTANCE CRITERIA	READ / SEE
1	Follow chapter 9.1 in Instructions for Use and complete calibration	See chapter 9.1 in I. Instructions for Use	Chapter 9.1 in I. Instructions for Use
2	Restart GazeDriver by pushing the on/off button (12)	GazeDriver is restarted	Illustration [4]
3	After restart GazeDriver is in Pause mode	Left LED (1) and right LED (3) are purple	
4	Set the wheelchair speed to its slowest value	Follow the wheelchair manual	Follow the wheelchair manual
5	User looks at the top middle virtual field - Virtual Field 2	The feedback LEDs blink (2)	Illustration [10]
6	Un-pause GD by looking at bottom middle virtual field (Virtual Field 5) until LED's stops flashing	If successful, no LEDs are on	See chapter 7.2 and 7.5 in I. Instructions for Use Illustration [10]
7	A. User looks at top middle virtual field - Virtual Field 2 B. User looks away from virtual field	A. User drives forward B. The wheelchair stops	See chapter 7.2 and 7.4 in I. Instructions for Use Illustration [10]
8	A. User looks at Virtual Field 1 B. User looks away from virtual field	A. The wheelchair turns left B. The wheelchair stops	See chapter 7.2 and 7.4 in I. Instructions for Use Illustration [10]
9	A. User looks at Virtual Field 3 B. User looks away from virtual field	A. The wheelchair turns right B. The wheelchair stops	See chapter 7.2 and 7.4 in I. Instructions for Use Illustration [10]
10	A. User looks at reverse virtual field (Virtual Field 4) B. User looks away from virtual field	A. The wheelchair reverses B. The wheelchair stops	See chapter 7.2 and 7.4 in I. Instructions for Use Illustration [10]

11	<p>User enters wheelchair settings (Virtual Field 4)</p> <p>The user adjust speed up one level.</p> <p>User exit menu. (A soft-lock might be experienced since GazeDriver has no way to know how the menu of the wheelchair is configured) See 7.9 Wheelchair settings mode</p>	<p>The speed of the wheelchair is changed</p> <p>A soft lock is not considered a failure (see 7.9 Wheelchair settings mode)</p>	<p>See chapter 7.2 and 7.8 in I. Instructions for Use Illustration [10]</p>
12	<p>Repeat step 11 but setting speed down again.</p>	<p>The speed of the wheelchair is changed</p>	<p>See chapter 7.2 and 7.8 in I. Instructions for Use Illustration [10]</p>
13	<p>Review chapter 7.11 with the user.</p> <p>If necessary, test driving with the wheelchair in a reclined position.</p>	<p>The chapter has been reviewed.</p>	<p>See chapter 7.11 in I. The Instructions for Use</p>
14	<p>First Use is concluded. Proceed to personalize the settings of GazeDriver</p>		<p>See chapter 8 in I. Instructions for Use</p>

INFORMATION MANDATORY FOR THE RETAILER TO APPLY

The retailer must insert the serial number and production date in the field below. This information can be found on the label under the GazeDriver Module (17).

It is also mandatory to insert contact information of the qualified personnel to perform the installation.

Serial number of the device	
The date of manufacture	
Contact information of qualified personnel to perform the installation	
Please note! When the mandatory contact information in this box is filled in, it automatically means that the installation instructions according to the "Installation and First Use" in this manual have been followed when installing GazeDriver.	

RESOURCES AND SUPPORT

If you need support, you can find information on the GazeDriver website.

<http://www.gazedriver.com>

Users with visual impairments can find the PDF files together with further information on the website.

👉 Contact your specialist dealer when required.

Alternatively, users with visual impairments can have the documentation read out by a helper.

A short easy read guide called "Quick Guide" is also available on our website.



Part of Meyra Group

Eyemind ApS
Vesterbrogade 125
1620 Copenhagen
Denmark